

SOT-23 Plastic-Encapsulate Voltage Regulators

79L18 Three-terminal positive voltage regulator

FEATURES

Maximum Output current I_O : 0.1 A

Output voltage V_O : -18 V

Continuous total dissipation P_D : 0.35 W ($T_a=25^\circ\text{C}$)

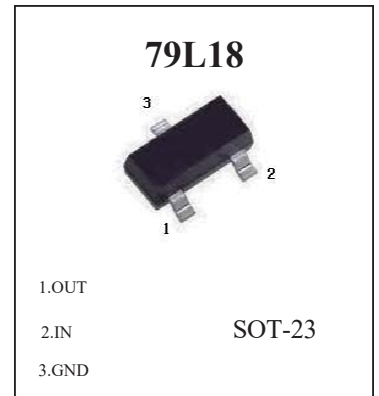

ABSOLUTE MAXIMUM RATINGS (Operating temperature range applies)

Parameter	Symbol	Value	Unit
Input Voltage	V_I	-35	V
Operating Junction Temperature Range	T_{OPR}	0-150	$^\circ\text{C}$
Storage Temperature Range	T_{STG}	-65-150	$^\circ\text{C}$

ELECTRICAL CHARACTERISTICS AT SPECIFIED VIRTUAL JUNCTION TEMPERATURE ($V_i=-26\text{V}, I_o=40\text{mA}, C_i=0.33\mu\text{F}, C_o=0.1\mu\text{F}$, unless otherwise specified)

Parameter	Symbol	Test conditions	Min	Typ	Max	Unit	
Output voltage	V_o	25°C	-17.3	-18.0	-18.7	V	
		$-20.5\text{V} \leq V_i \leq -33\text{V}, I_o=1\text{mA} \sim 40\text{mA}$	$0-125^\circ\text{C}$	-17.1	-18.0	-18.9	V
		$I_o=1\text{mA} \sim 70\text{mA}$		-17.1	-18.0	-18.9	V
Load Regulation	ΔV_o	$I_o=1\text{mA} \sim 100\text{mA}$	25°C	27	170	mV	
		$I_o=1\text{mA} \sim 40\text{mA}$	25°C	19	85	mV	
Line regulation	ΔV_o	$-20.5\text{V} \leq V_i \leq -33\text{V}$	25°C	70	325	mV	
		$-22\text{V} \leq V_i \leq -33\text{V}$	25°C	60	275	mV	
Quiescent Current	I_q		25		6.5	mA	
Quiescent Current Change	ΔI_q	$-22\text{V} \leq V_i \leq -33\text{V}$	$0-125^\circ\text{C}$		1.5	mA	
		$1\text{mA} \leq I_o \leq 40\text{mA}$	$0-125^\circ\text{C}$		0.1	mA	
Output Noise Voltage	V_N	$10\text{Hz} \leq f \leq 100\text{KHz}$	25°C	150		μV	
Ripple Rejection	RR	$-21.5\text{V} \leq V_i \leq -31.5\text{V}, f=120\text{Hz}$	$0-125^\circ\text{C}$	33	48	dB	
Dropout Voltage	V_d		25°C	1.7		V	

* Pulse test.

TYPICAL APPLICATION

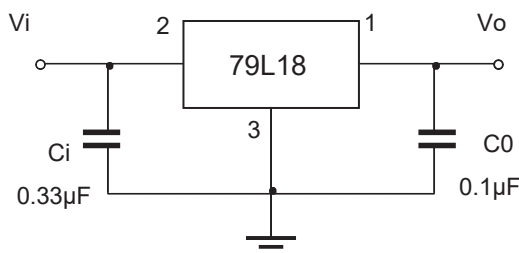

Note: Bypass capacitors are recommended for optimum stability and transient response and should be located as close as possible to the regulators.

Typical Characteristics

Output Characteristics

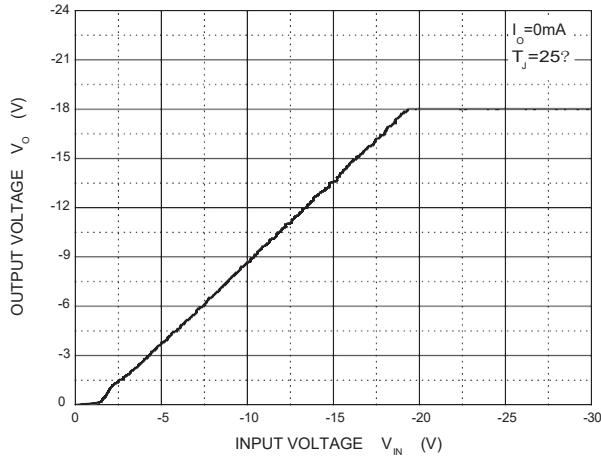

Dropout Characteristics

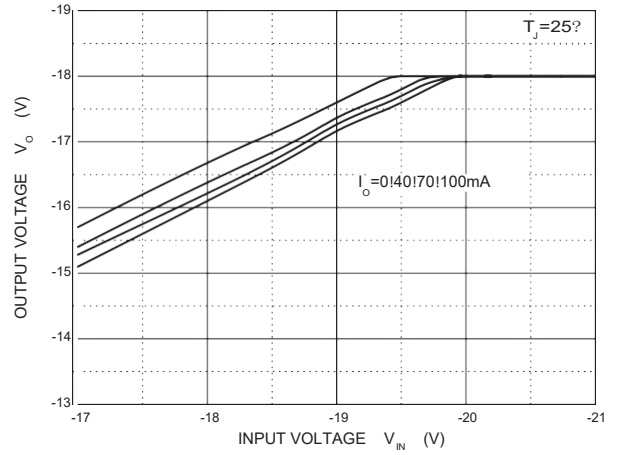

Quiescent Current vs Input Voltage

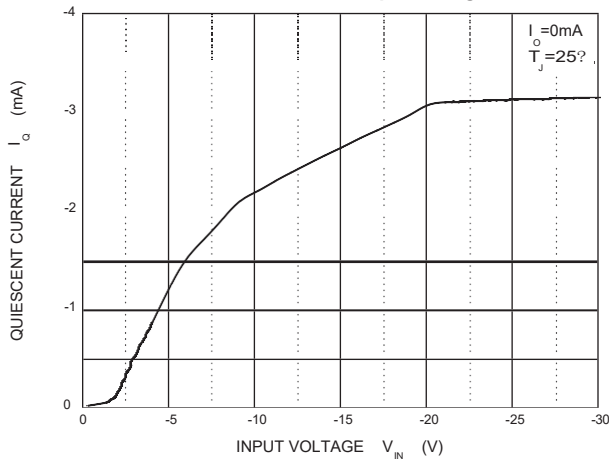

Current Cut-off Grid Voltage

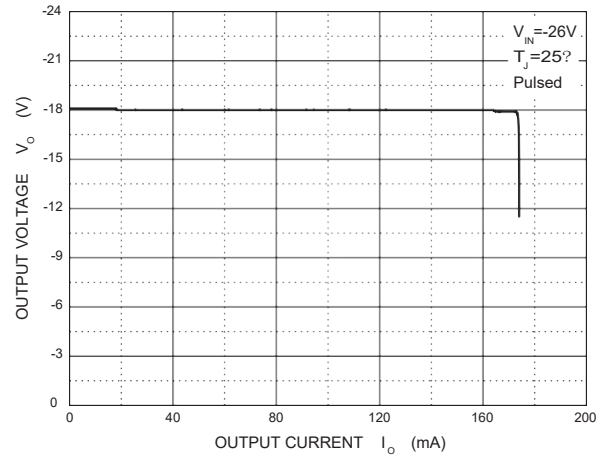

Output Voltage vs Junction Temperature

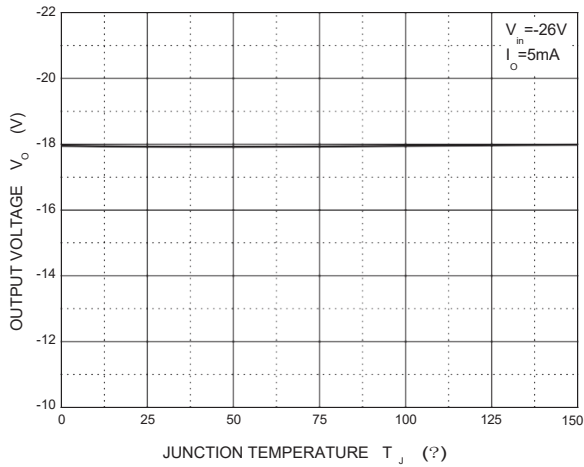

Power Derating Curve

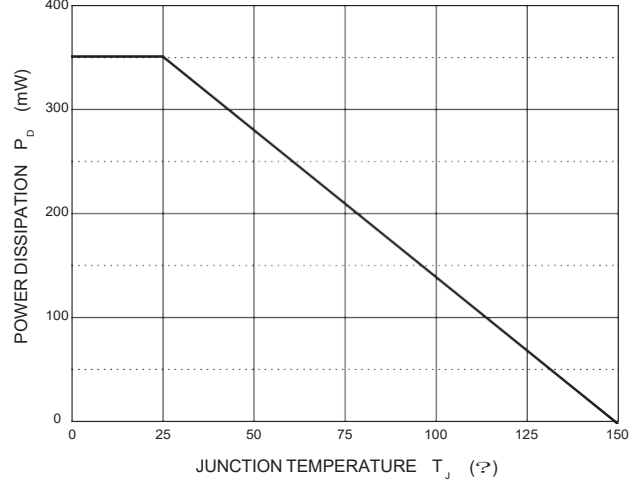

PACKAGE OUTLINE

Plastic surface mounted package; 3 leads

SOT-23

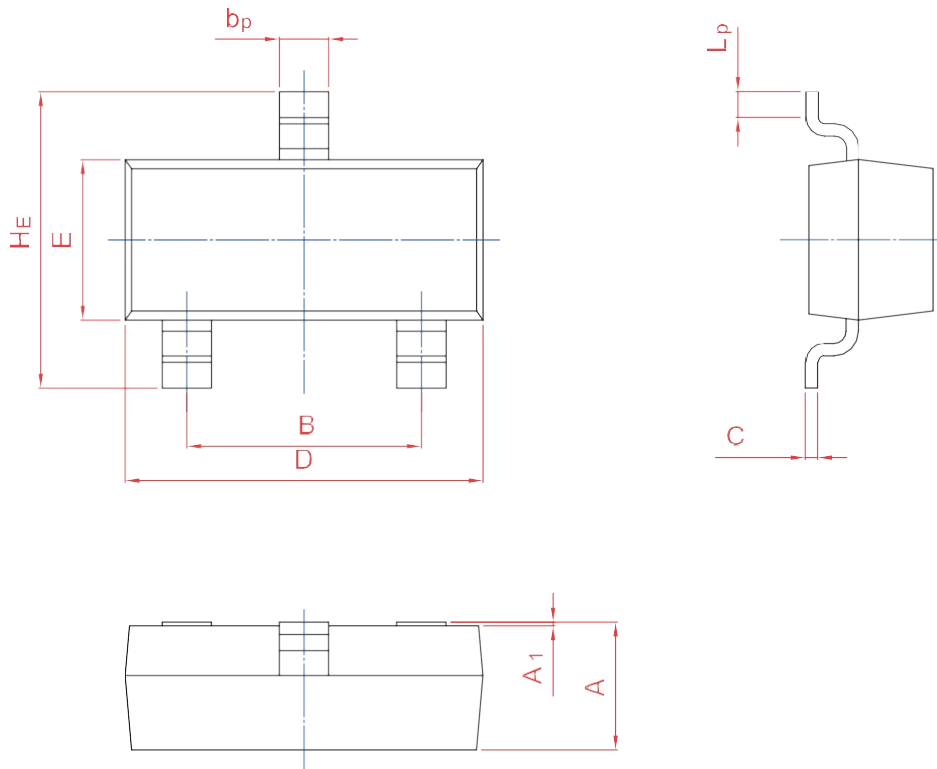
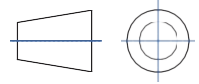

UNIT	A	B	b _p	C	D	E	H _E	A ₁	L _p
mm	1.40 0.95	2.04 1.78	0.50 0.35	0.19 0.08	3.10 2.70	1.65 1.20	3.00 2.20	0.100 0.013	0.50 0.20