

SOT-23 Plastic-Encapsulate Voltage Regulators

79L15 Three-terminal positive voltage regulator

FEATURES

Maximum Output current I_O : 0.1 A

Output voltage V_O : -15 V

Continuous total dissipation P_D : 0.35 W ($T_a=25^\circ\text{C}$)

ABSOLUTE MAXIMUM RATINGS (Operating temperature range applies)

Parameter	Symbol	Value	Unit
Input Voltage	V_I	-35	V
Operating Junction Temperature Range	T_{OPR}	0-150	$^\circ\text{C}$
Storage Temperature Range	T_{STG}	-65-150	$^\circ\text{C}$

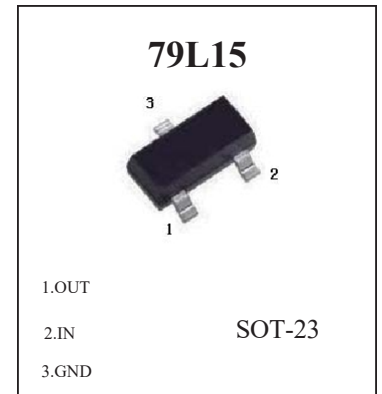

ELECTRICAL CHARACTERISTICS AT SPECIFIED VIRTUAL JUNCTION TEMPERATURE ($V_i=-23\text{V}, I_o=40\text{mA}, C_i=0.33\mu\text{F}, C_o=0.1\mu\text{F}$, unless otherwise specified)

Parameter	Symbol	Test conditions	Min	Typ	Max	Unit	
Output voltage	V_o	25°C	-14.4	-15.0	-15.6	V	
		$-17.5\text{V} \leq V_i \leq -30\text{V}, I_o=1\text{mA} \sim 40\text{mA}$	0-125 $^\circ\text{C}$	-14.25	-15.0	-15.75	V
		$I_o=1\text{mA} \sim 70\text{mA}$		-14.25	-15.0	-15.75	V
Load Regulation	ΔV_o	$I_o=1\text{mA} \sim 100\text{mA}$	25°C	25	150	mV	
		$I_o=1\text{mA} \sim 40\text{mA}$	25°C	15	75	mV	
Line regulation	ΔV_o	$-17.5\text{V} \leq V_i \leq -30\text{V}$	25°C	65	300	mV	
		$-19\text{V} \leq V_i \leq -30\text{V}$	25°C	50	250	mV	
Quiescent Current	I_q		25		6.5	mA	
Quiescent Current Change	ΔI_q	$-19\text{V} \leq V_i \leq -30\text{V}$	0-125 $^\circ\text{C}$		1.5	mA	
		$1\text{mA} \leq I_o \leq 40\text{mA}$	0-125 $^\circ\text{C}$		0.1	mA	
Output Noise Voltage	V_N	$10\text{Hz} \leq f \leq 100\text{KHz}$	25°C	90		μV	
Ripple Rejection	RR	$-18.5\text{V} \leq V_i \leq -28.5\text{V}, f=120\text{Hz}$	0-125 $^\circ\text{C}$	34	39	dB	
Dropout Voltage	V_d		25°C	1.7		V	

* Pulse test.

TYPICAL APPLICATION

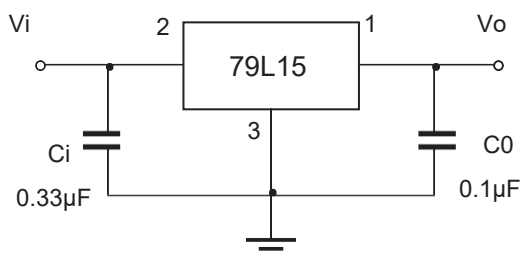

Note: Bypass capacitors are recommended for optimum stability and transient response and should be located as close as possible to the regulators.

Typical Characteristics

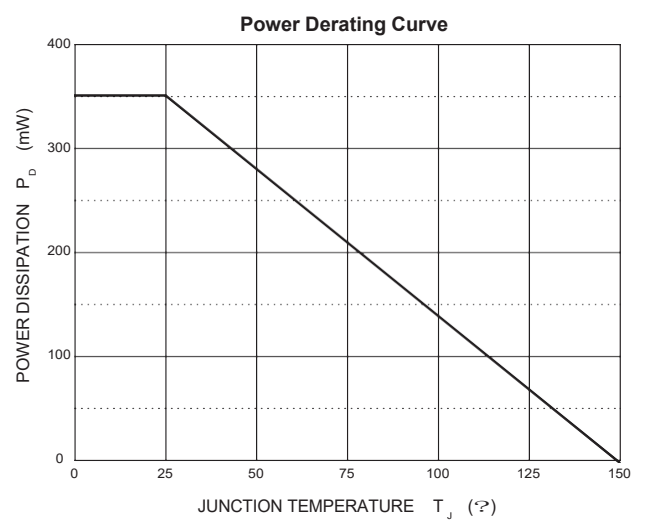
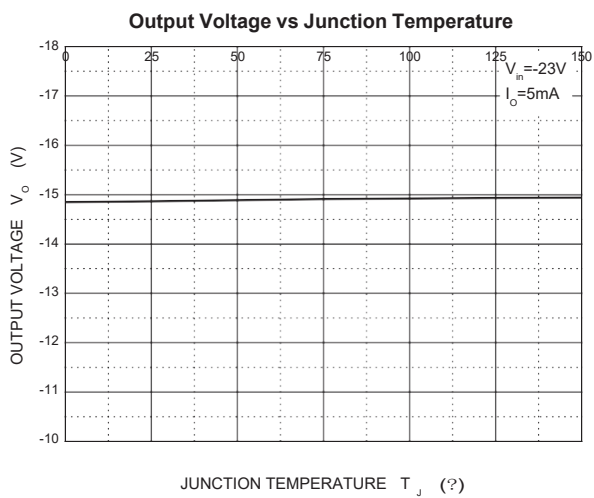
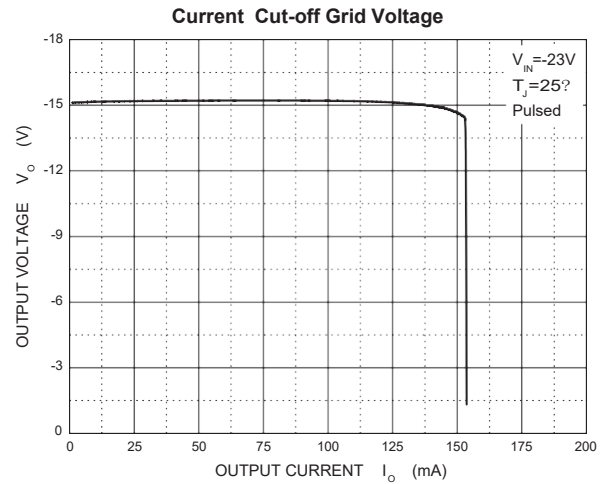
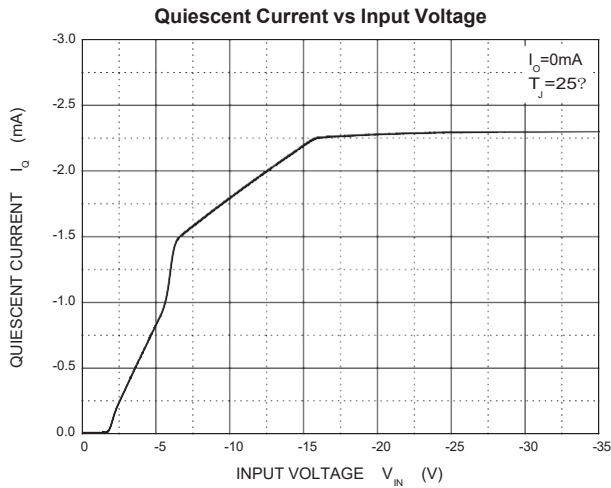
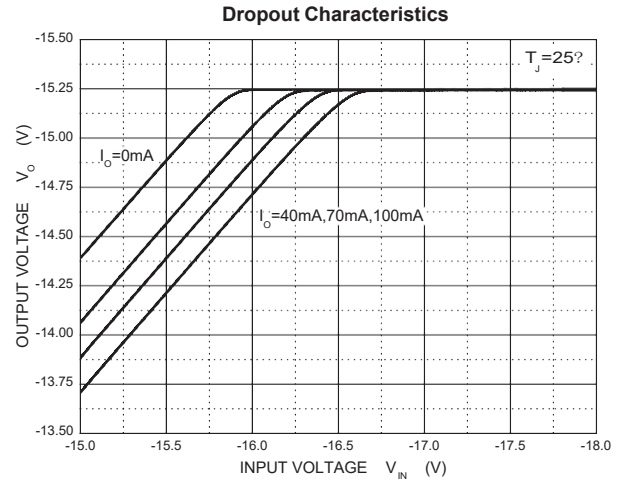
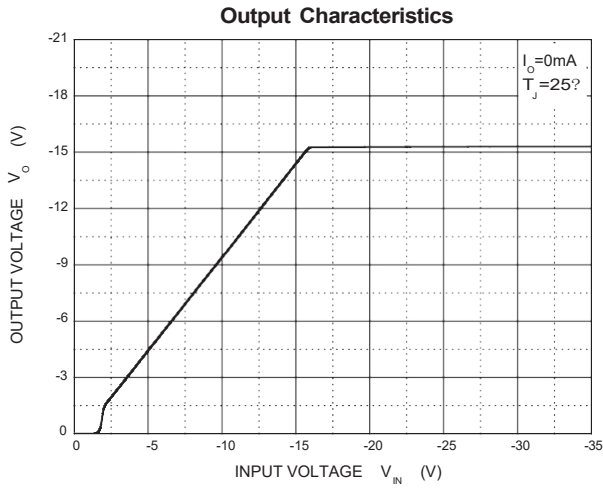

PACKAGE OUTLINE

Plastic surface mounted package; 3 leads

SOT-23

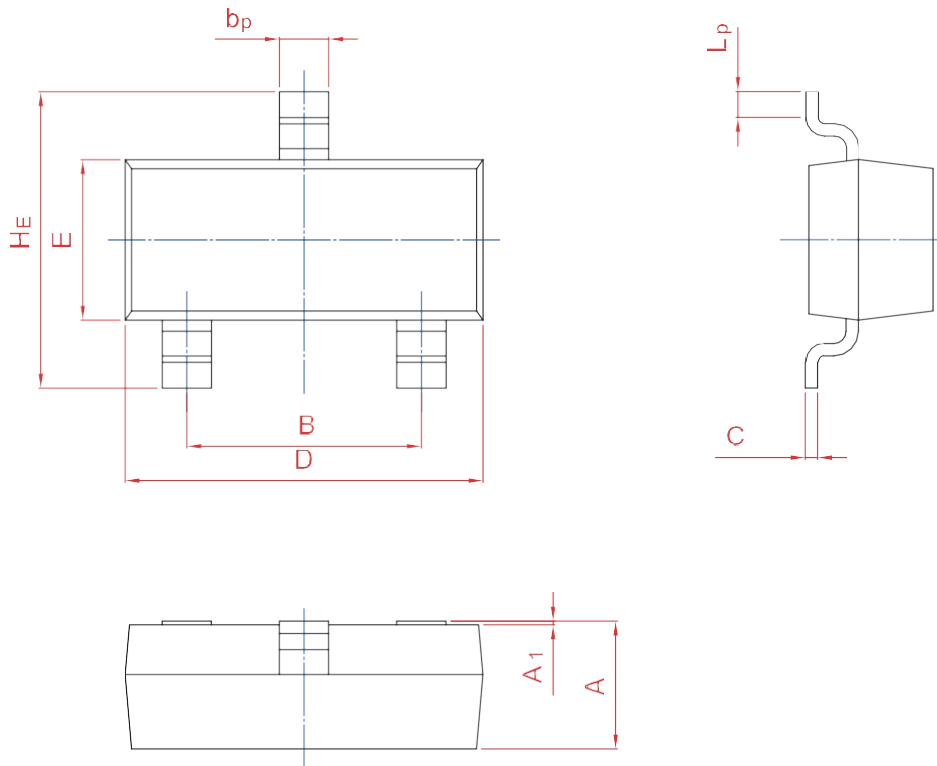
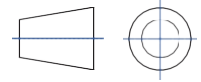

UNIT	A	B	b _p	C	D	E	H _E	A ₁	L _p
mm	1.40	2.04	0.50	0.19	3.10	1.65	3.00	0.100	0.50
	0.95	1.78	0.35	0.08	2.70	1.20	2.20	0.013	0.20